

A GRAPHIC METHOD TO AID SPECIFIC DETERMINATION  
OF FUSULINOIDS AND SOME RESULTS OF ITS APPLICATION  
TO THE FUSULINÆ FROM N. CHINA.

WITH 2 PLATES AND 20 TEXT-FIGURES.

By J. S. LEE (李四光, 仲毅)

Professor of Geology in the National University, Peking.

Informations regarding the character and distribution of the Forami-  
fera under discussion have so richly accumulated in recent years and are so  
widely scattered that a coordination of the established facts or an adjustment  
of different views would seem a step that, if it does not in itself, reveal new  
points of interest, is certainly necessary to pave the way for further research in  
a land like our own where the former seas were once swarmed with these  
organisms. The necessity is all the more acutely felt when one is not  
disposed to appreciate those sharp criticisms as now and again appear in  
palaeontological literature against the negligence or ignorance of the prior  
published results<sup>(1)</sup>. Criticism of that kind might be easily avoided if  
knowledge were brought together in a way more accessible.

With a limited library it has been practically impossible for the  
unfortunate student of these animals like the present writer, to start a  
systematic survey of the literature with desired thoroughness. Nevertheless  
an attempt had been made to gather together directly or indirectly the gist of  
the more important contributions relating to the structure of these fossils, and  
to assign to them, as near as possible, their respective value. The results thus  
obtained were formulated in a previous paper read by title at the First Annual  
Meeting of the Geological Society of China, and are substantially embodied in  
the present communication. This is the reason why the scope of this paper  
may appear to have extended slightly beyond the limit than its title would  
legitimately cover.

- (i) *General discussion on the Methods of Research and Terms for  
Fusulinidæ with a Critical Review of the more Important  
Results formerly obtained.*

(1) H. Staff, *Palaeontographica*, Bd. LIX, pp. 186-191; et *Bull. Geol. Inst. Upsala*, Vol.  
X, No. 19-20, 1910-11, p. 111.

Although as early as in 1829 Fischer v. Waldheim<sup>(1)</sup> published a somewhat detailed account of *Fusulina* it was not until the appearance of the results of Möller's research (1877-1879)<sup>(2)</sup> in palaeontological literature that the internal structure of this group of Foraminifera and their kindred forms was made known to any extent. There is much to be attributed to Möller's detailed observations; but the chief merit of his study seems to lie rather in his systematic application of the method of thin-sectioning to an ample quantity of material that was then available to him. Since that date the method of thin-sectioning became more and more widely adopted with the result of rapid promotion of our knowledge regarding these highly specialized Foraminifera. We recognize to-day at least six distinct groups of these animals: They are *Fusulinella*, *Fusulina* (*Schellwienia*), *Schwagerina*, *Dolioina*, *Neoschwagerina*, *Sumatrina*. Such forms like *Schubertella*, *Girtyina*, *Verbeekina* *Yabeina*, for the reason of their intermediate character, being left out of account.

The method of thin-sectioning, powerful as it is, is not incapable of further improvement. It has been the main object, and at the same time the difficulty for the student of these minute fossils to obtain an axial or a longitudinal section and an equatorial or a transverse (median) section of one and the same species. Having obtained such sections or at least when it is believed that such sections are obtained the reconstruction of the entire "skeleton" of the animal is then attempted by an exercise of imagination. This method of treatment obviously implies firstly, that all the observable properties of the animal can be reconstructed on the basis of the two sections, and no single feature as appears in the thin-sections will possibly lead to different interpretations of its three dimensional character; secondly, that we are absolutely sure of the two sections being derived from one and the same species. In practice however these can by no means be freely admitted.

- 
- (1) Fischer v. Waldheim, Ueber *Fusulina*, Bull. Soc. Imp. d. Naturalistes d. Moscou, T. I, p. 329.
- (2) V. v. Möller, Ueber *Fusulina* und ähnliche Foraminiferenformen des Russischen Kohlenkalks, Neues Jahrb. f. Min. Geol. u. Pal., 1877; Die Spiral-gewundenen Foraminiferen des Russischen Kohlen-Kalks, Mém. Acad. Imp. Sc. St-Petersbourg, VII sér., t. XXV, No. 9, 1878; Die Foraminiferen des Russischen Kohlenkalks, Mém. Acad. Imp. Sc. St-petersbourg, VII sér., t. XXVII, no. 5, 1879.

Discussions<sup>(1)</sup> regarding the presence or absence of the basal skeleton in *Vebeekina*, and the alleged possibility<sup>(2)</sup> of attaining a section characteristic of "*Schwagerina verbeeki*" by a suitable orientation of *Schwagerina princeps* are interesting cases that illustrate the unavoidable consequences involved in the first assumption. In looking through the published microphotographs and specific descriptions it is invariably to be noticed that the authors tacitly assume the specific identity of the longitudinal and transverse sections which they regard as belonging to one and the same species. Thus, there are cases where the specific identity is almost self-evident, and needs no further demonstration; but there are again cases where it is equally obvious that the specific identity is far too problematical as to be admitted on a *coup d'oeil*.

What appears to be a more adequate method is to make two series of parallel sections through the same individual—a method which may well be resorted to especially in determining the true nature of such dubious parts like the dark spots that are seen in the longitudinal section on the lower fringe of the "septa" of *Schwagerina princeps* SCHWAGER<sup>(3)</sup>. Features of similar description sometimes appear in thin sections without revealing any obviously attributable significance, and may yet prove to be of vital importance for locating the phylogenic position of the animal.

Starting with a whitish speck that appears on a polished surface of a rock, we may begin to prepare, by proper orientation and adjustment, the first series of sections parallel to the axis of the whorl until the true axial section is obtained. Observations can be made by means of reflected light while the preparation of the sections is in progress. The second series of sections must be taken perpendicular to the axis of the whorl, that is, parallel to the median (transverse) section. These sections of half of the test are again duly examined by reflected light until the median section is reached, and reduced so thin as to permit the examination by transmitted light. As the

- 
- (1) H. Staff, Beiträge zur Kenntnis der Fusuliniden. N. J. f. M. G. u. P., Beil.-Bd XXVII, pp. 471-472, 1909.
  - (2) Y. Ozawa, Preliminary notes on the Classification of the Family Fusulinidæ (in Japanese), Journ. Geol. Soc. Tokyo, Vol. XXIX, No. 348, 1922, pp. 362-365.
  - (3) H. H. Hayden, Fusulinidæ from Afghanistan, Rec. Geol. Sur. India, 33, 1909.
  - (3) C. Schwager, Carbonische Foraminiferen aus China u. Japan; China, Bd. IV, Pl. XVII Fig. 1.

axis of the whorl deviates only slightly from the axis of pseud-symmetry for the overwhelming majority of Fusulinidæ the loss of half of the test through the preparation of the sections parallel to the axis would not materially hamper our observation on the sections perpendicular to the axis. Difficulties however sometimes arise in connexion with the application of reflected light. But they are not insurmountable. The writer has found in certain kind of rocks for instance, the Chientaokou Limestone of Taiyuan, Shansi, which is of earthy composition and fissile character, the use of reflected light actually furnishes a clearer image of the minute parts of the fossil than what is revealed under transmitted light. For *Fusulina* embedded in pure limestones it is as a rule possible to render the minute structures sufficiently clear for observation under reflected light if the polishing is carried to a degree of fineness. Only in rare cases when some suitable etching or staining reagents are needed. As the reagent to be used depends not only on the composition but also on the texture of the rock in which the minute fossils are embedded no general rule can be laid down.

Having once established the specific or generic characters as the case may be, it is not necessary to go through the complete process for the identification of a given specimen; for the axial or the equatorial sections would then carry more definite meaning than they would otherwise do.

This method of treatment has enabled the writer to determine with confidence, the shape of the test, the type of fold and the height of the so-called septa, of several specimens of *Fusulina*. There seems no reason why it cannot be applied with advantage to elucidate some of the ill-understood parts in the higher forms.

Turning now to the salient structural features of the various types of Fusulinidæ. Inasmuch as some of these features are more or less involved in our present discussion a brief summary of the more important observations made by different authors in the past may not be out of place. It is to be noted at the outset that the constitution of the circumferential or spiral wall of the chamber is, as already shown by Douvillé,<sup>(1)</sup> Staff and others, non-porous

(1) H. Douvillé, Les Calcaires à Fusulines de l'Indochine, Bull. Soc. Géol. France, 4e sér. t. VI, No. 7, 1906, 580.

throughout the family Fusulinidae, and consists of a honey-combed framework for which the author proposes the name macula,<sup>(1)</sup> covered externally by a thin plate, the "Dachblatt" or "lame spirale" of German and French writers. In the absence of an equivalent English term, the writer ventures to call it the tectum after the German term Dachblatt.

The true nature of the so-called septa is however a point that requires further illumination. Some of the forms like *Fusulina secalis* (Girty em. STAFF) and *Schwagerina princeps* seem to possess porous "septa" as shown by Schellwien and Staff;<sup>(2)</sup> while others yield little or no trace of such pores when tangential sections are made and examined under a high powered microscope. The writer has found in *Fusulina variata* n. sp. and other species that the apparent pores, though mostly somewhat larger than the inter-space in the honey-comb of the macula, merge into the latter space in the region where the wall begins to bend inward. Further investigation seems to be necessary before the porous nature of the "septa" can be admitted as a fact.

The so-called septa in all *Fusulina* and the "primary septa"<sup>(3)</sup> in the higher forms are but anterior, reentrant continuation of the walls and therefore they cannot be regarded as septa in the true sense of the term such as used in the Anthozoa. Dr. Girty seems to object this term, for he calls them the radial walls.<sup>(4)</sup> As the result of a discussion with Prof. A. W. Grabau the decision was arrived at that in order to avoid confusion and misconception the terms, wall and septa, for this group of animals should be replaced or partially replaced by more suitable ones. We propose to call the walls, both radial and spiral collectively the theca, the superior or the spiral portion the spirotheca and the radial or anterior portion the antetheca which is equivalent to the old term septa.

In *Fusulinella* and the lower forms of *Fusulina* the theca usually consist of a single layer of testaceous substance, namely the tectum, while in the higher forms of Fusulinidae the theca or at least the spirotheca are

- (1) From the fact that it presents a spotted or irregularly reticulate appearance in the tangential section.
- (2) H. Staff, *Palaeontographica*, Band LVI, p. 152. idem., Band LIX, pp. 187-188.
- (3) H. Yabe, A Contribution to the Genus *Fusulina*, Jour. Coll. Sc. Imp. Uni. Tokyo, Vol. XXI, Art. 5, p. 1.
- (4) G. H. Girty, The Guadalupian Fauna, U. S. Geol. Surv. Prof. Paper No. 58, p. 63.

mostly composed of two layers of testaceous substance, the inner one being called the macula and the outer one the tectum.

Partitions or hanging walls of different nature appear in *Neoschwagerina* and *Sumatrina*. They seem to have developed, at least in some cases, by the enlargement and prolongation of the dark club-like bodies (seen in section) which form the support to, or pendant from the tectum. These partitions including the antetheca probably served the animal similar purposes, but it is obvious that they have arisen from different origin. If the term septa is to be used at all these over-hanging partitions or semi-partitions would certainly seem to have the preferential right to claim such a name, for they form a system of frame-work, like the double bottom of a ship, dividing and sub-dividing a chamber into chamberlets. They are in certain respects equivalent to the antethecal folds in *Fusulina*. As they are mere attachments to the tectum they probably do not indicate intervals of arrest in the forward growth of the animal as seem to be the case with the formation of the antetheca.

The septa thus defined may run in the direction perpendicular to the axis of the whorl, they are then called the transverse septa, or may run parallel to the axis of the whorl, they are then called the longitudinal septa. And again they may extend from the inner side of the spirotheca downwards until they coalesce with the protrusions on the floor of the chamber, namely, the "basal skeleton". These may be termed the principal septa, while the lesser ones which only reach half way down the chamber are called the auxiliary septa.

In *Fusulinella*, *Fusulina*, *Schwagerina* and *Doliolina* there are no true septa. According to H. H. Hayden,<sup>(1)</sup> transverse septa alone are found in a certain form for which he proposes the name *Cancellina*. In *Neoschwagerina* principal transverse septa always present being accompanied only in rare cases by auxiliary transverse septa. On the contrary, the longitudinal septa in *Neoschwagerina* are, as a rule, auxiliary. Only very rarely do they seem to have developed to principal septa, that is, to form a complete partition more or less parallel to the antetheca. It is only in *Sumatrina* of the type of

---

(1) loc. cit.

*S. multiseptata* DEPRAT<sup>(1)</sup> that complete development of principal and auxiliary septa both in the longitudinal and transverse directions seems to have been accomplished.

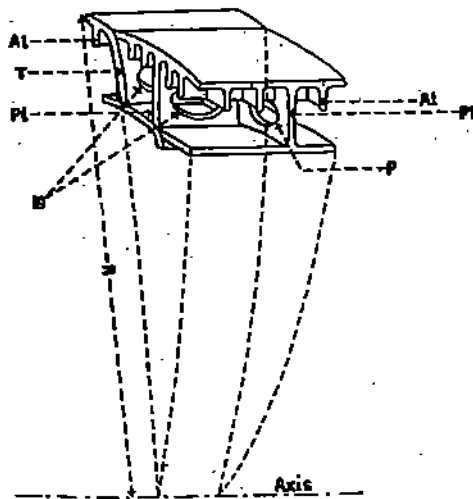

An idealized diagram showing the highest development of Fusulinidae.

- T. antetheca.
- Pl. Principal longitudinal septa
- Al. Auxiliary longitudinal septa.
- Pt. Principal transverse septa.
- At. Auxiliary transverse septa.
- P. Lateral passage.
- M. Buccal aperture.

Fig. 1.

The buccal aperture, or simply the aperture, is the opening in the lower part of the antetheca and also of the principal longitudinal septa if the latter present. The opening may be simple being then situated in the equatorial position, or may be multiple consisting of a series of slits arranged in the longitudinal direction. Each of the slit leads to a secondary chamber formed either by a projecting ridge on the floor, the basal skeleton, as in *Doliolina*, or by principal transverse septa as in *Neoschwagerina* and *Sumatrina*. Openings are also present in principal transverse septa serving as a channel of communication from secondary chamber to secondary chamber in the longitudinal direction. These are obviously physiologically as well as structurally necessary. They might be termed the lateral passages as distinguished from the buccal aperture.

These structural features, namely the presence or absence of folds in the antetheca, of the basal skeleton, of the auxiliary or principal septa in the longitudinal and transverse directions together with simple or multiple nature of the aperture provide the bases for the determination of the leading types of Fusulinidae. It is not a matter of serious concern whether we treat such types

(1) J. Deprat, Étude géol. d. Yun-nan Oriental, IIIe partie, p. 54, pl. III Fig. 2-S.

as sub-families or genera. Usually there is little difficulty in attributing a given individual of Fusulinidæ to a particular type, but it is not always easy to determine the specific characters which must be found in the minor variations within a given type. This is especially the case when we come to deal with *Fusulinas*; for, structurally there is in them but little variation.

In discussing the forms of Foraminifera in general, Douvillé<sup>(1)</sup> makes a just remark that the morphological diversity of the test of these primitive animals is conducive to a simple law, namely, uniform growth with uniform disposition. This however does not explain the various structural types of Fusulinidæ. If we were to offer an opinion to supplement Douvillé's view nothing would seem more natural than to presuppose that the structural strength is one of the most important factors that have determined the development of this particular group of Foraminifera.

Starting from *Fusulinella*, we see two ways of adaptation possible in order to attain the necessary strength for the increased size of its fragile test; namely, by folding its antetheca, as Ammonoids have done in the development of complicated suture, or by addition of some frame-work or a system to frame-works. Nature has taken both of these courses. *Fusulina* represents one branch, and *Doliolina-Sumatrina* represent the other. Granting this view, we can readily see why it is necessary for *Fusulina* to develop folds in the antetheca, and for *Doliolina* and *Neoschwagerina* to develop septa; for, as already remarked, the latter serves the same structural purpose as the former. Even the bulging of the free end of the auxiliary septa and sometimes of the antetheca to a club-like shape as seen in a transverse section, becomes intelligible on this view, for such would be the most economical distribution of a given quantity of matter to obtain the maximum resistance against stress and strain.

Further, a consideration of the external form of *Fusulina* along similar lines may yet yield some important results. In tracing the developmental history of the arcuate forms of *Fusulina*, for instance, we may naturally be led to assume the existence of a form that had developed to a

(1) H. Douvillé, Evolution et Enchaînements des Foraminifères, Bull. Soc. Géol. France, 4e sér. t. VI, fasc. 7, p. 589.



considerable length; and on that account, it had gradually to adapt an arcuate form so as to minimize the chance of fracture across the middle part of the body, which is the weakest part in the test especially when elongated. Such abnormally long forms do actually exist, e. g. *Fusulina extensa* and *Fusulina longissima* though further evidence is needed to prove that they are the ancestors from which the arcuate varieties descended. Nevertheless this line of argument can provide us a basis for delineating at least two branches of organisms in the pedigree of *Fusulina*: The one, as represented by *Fusulina eecalis*, largely remained in the form of their ancestor, *Fusulinella*, namely sub-globose and the other, as represented by *Fusulina extensa*, namely elongated, leading up to the highly specialized varieties with an arcuate test.

For a long time it has been tacitly assumed and in some cases definitely stated that the line of evolution of the family Fusulinidæ runs from *Fusulinella* to *Fusulina* then to *Schwagerina*, *Neoschwagerina* and so forth<sup>(1)</sup>. The assumption is not altogether unfounded on facts, and parts of the assumption may now be well considered as established facts. But in it there are parts that are founded on too flimsy a basis. It would not be to the point of our present discussion, if we were to attempt a complete solution of these genetic problems at large. In passing, it may however be noted that it is practically certain that *Fusulinella* is the common ancestor of the whole family of Fusulinidæ, that *Fusulina* is directly derived from *Fusulinella*, and that *Doliolina*, *Neoschwagerina* and *Sumatrina* constitute an independent branch succeeding one another.<sup>(2)</sup> Transitional forms between *Fusulina* and *Schwagerina* are said to exist under the names *Schwagerina fusiformis* Krotow and *Schwagerina fusulinoides* Schellw. In the former however there is to be observed in a poor transverse section,<sup>(3)</sup> save the somewhat unusually thick spirotheca, and perhaps some irregularities in the antetheca

(1) It is to be regretted that the writer has not had the opportunity to refer to the discussion on the development of Fusulinidæ by H. Staff while writing these lines. (Beiträge zur Kenntnis der Fusuliniden, N. J. f. M. G. u. P., Beil.-Bd. XXVII, 1909)

(2) The fact may be mentioned here to support this view, that the writer arrived at this opinion without any previous knowledge of what has already been expressed by Deprat concerning the direct descent of *Schwagerina* from *Fusulinella* (Mémoires du Service Géol. de l'Indochine, 1912, Vol. I, Fasc. III, p. 72), and by Staff the direct descent of *Verbeekina* from *Fusulinella* (Bull. Geol. Instre Upsala, Vol. X, p. 114.)

(3) Palæontographica. Bp LIX, p. 178, Fig. 8.

few characters that deviate from *Schwagerina* of the normal type; and in the latter<sup>(1)</sup> the fact that the inner volutions possess a semblance of character of *Schwagerina* with the outer ones approaching the form of *Fusulina* would rather tend to show that it represents the transition from *Schwagerina* to *Fusulina* rather than the reverse. In other words, it would be more properly viewed as a case illustrating the adaptation of some form of *Schwagerina* to a Fusulinoid type perhaps by force of circumstances. It seems highly probable that both *Fusulina* and *Schwagerina* are direct descendants from some advanced form of *Fusulinella* through parallel development.

With due allowance for the possible influence played by changed environment, it would still seem a strange anomaly, in view of the law governing the direction of mutation<sup>(2)</sup> commonly observed by various and varying organisms if these Foraminifera whose common ancestor equipped with straight antetheca, would first adapt numerous folds in their antetheca as in *Fusulina*, and then return to their original form, namely with straight antetheca as in *Doliolina*, *Neoschwagerina*, etc., or would first alter their test from sub-spherical to elongated and then return to their original sub-spherical form. Even in *Tricites*<sup>(3)</sup> of Dr. Girty which are noted for their unfuted antetheca and strongly inflate form, folds are not absent; and indeed their association with *Fusulina centralis* and other facts seem to indicate that they too, probably tend to elongate in the axial direction.

Leaving now the discussion on the outstanding features—largely structural—of the leading types of Fusulinidæ, and their phylogenic relations, we may deal with problems that would arise in connexion with specific determination within a particular type of Fusulinidæ. As *Fusulina* are widely distributed in N. China (see Fig. 20), it has been anticipated that a careful determination of these fossils may afford us a rigorous means for correlating the strata in which they are found. Under these circumstances we are led to pay more attention for the present, to *Fusulina* than to any other group in the family.

- 
- (1) Palæontographica Bd XLIV, pp. 259-260, Taf. XXI, Fig. 2.
  - (2) M. Neumayr, Die Stamme des Tierreiches, Bd. I, pp. 60, 61, 1889.
  - (3) H. F. Osborn, The Continuous Origin of Certain Unit Characters as Observed by a Palæontologist, Harvey Soc. Vol., Nov. 1912, pp. 153-204.
  - (3) G. H. Girty, *Tricites*, a new Genus of Carboniferous Foraminifera, Am. Journ. Sc., XVII. 1901, pp. 234-240.

Again our consideration would resolve itself into two aspects: structural and morphological. Deprat has attempted a system of classification of *Fusulina* largely based on the structural types of the antetheca. This simple and apparently natural classification, if testified by a sufficiently large body of facts, would prove to be the most comprehensive and practical. But when we come to the facts it appears doubtful whether the five types of antetheca<sup>(1)</sup> are each represented by any number of individuals, and whether they are at all of taxonomic value. And indeed it would seem a dangerous proposition to dwell on a certain feature that happens to fall in our observation, as a property of sub-generic or specific value, for the simple reason that we do not know what are the more important characters that betray the natural history of these animals whose mode of life we are as yet ignorant of.

Apart from these somewhat hypothetical variations in the antetheca few structural differences are detectable in various species of *Fusulina*. We are then more or less compelled to direct our attention to the morphological aspect. Morphological variations in the test or parts of the test are observable throughout all forms of *Fusulina*. But the differences are in many cases so slight that unless some method of precision be adopted to record the facts it would be of no avail either to specific determination or to illustrating the developmental history of this group of Fusulinidae. This is especially so when we have a large mass of material to be dealt with.

Formulae like that for the cyclocentric conchospiral,<sup>(2)</sup> may be applied by way of attaining precision, if they be found to hold for a particular species or a group of species. And undoubtedly these are of high theoretical interest for morphologists; but for specific determination, the formulae themselves demonstrate that they can serve no practical purpose.

(1) J. Deprat, *Étude Géol. d. Yunnan Oriental*, Mém. Serv. Géol. Indochine, Vol. I, Fasc III, 1912, p. 8.

(2) C. F. Naumann, *Ueber die Spiralen der Conchylien*, *Abh. bei Begründung d. königl. sächs. Gesellsch. d. Wissenschaft*, 1846, pp. 151-196. *Ueber die cyclocentrische Conchospirale etc.*, *Abh. d. mathem.-phys. Classe d. königl. sächs. Gesellsch. d. Wissenschaft*, 1858, Theil I, pp. 168-195.

A simplified formula for cyclocentric conchospiral is quoted in the following page.

Another way to approach the same goal is to plot the "septadiagrams". These have been shown practically useful when a comparison between different and yet allied forms becomes necessary. This method is however open to the criticism that the diagram indicates only the number of antetheca in each volution, and the commencement of each volution is generally taken in a more or less arbitrary way. When plotted on a strict mathematical basis, the curve appears in the form of a series of discontinuous straight lines. From such a diagram, it appears as if, at certain stages of its life-history, the animal suddenly alters its mode of growth, if the formation of a single chamber or the antetheca represents, as it probably does, one definite step in the history of its development. Such a sudden change does not seem to be a natural state of things, and therefore no discontinuity should appear in diagrams even if they are constructed for a specific purpose.

After a careful survey of the more salient features of *Fusulina*, it is possible to establish a number of criteria which must come into our consideration in connexion with specific determination. They are,—

- (1) Length of the radius vector at any point of the outer surface of the spirotheca. This will incidentally indicate the height of each chamber.
- (2) Axial ratio, namely the ratio of the radius vector to the axial length at any point on the outer surface of the spirotheca.
- (3) Thickness of the spirotheca at all stages of its growth.
- (4) Cumulative number of antetheca at all stages of its growth.
- (5) Number of volutions in the complete test. This is also indicated by the vectorial angle.

Continued from footnote (2) on the previous page

$$r = \alpha + \frac{a}{p-1} \left\{ \begin{array}{l} \frac{\theta}{2\pi} \\ p \quad -1 \end{array} \right\}$$

where  $r$  = radius vector for the spiral,  
 $\alpha$  = radius of central chamber,  
 $a$  = height of the spiral at the end of its first volution,  
 $p$  = quotient of revolution, or the ratio between the heights of the succeeding chambers in the same vectorial direction,  
 $\theta$  = angle described by the radius vector.

- (6) Form and dimension of the embryonal or central chamber or a system of chambers.
- (7) Type of fold of the antetheca.
- (8) Structural and morphological peculiarities in the region where the spirotheca transforms itself into antetheca.
- (9) Form and position of the buccal aperture.
- (10) Axial curvature of the test, or any irregularity in form along the axial direction.

It will be seen at once that a random enumeration of the facts indicated above, or a formidable display of tabulated measurements as hitherto has been the practice with the authors who have dealt with these forms, lacks of that precision and lucidity which are called for at once in comparative studies. A glance at some of the tabulated results that the writer has obtained (see p. 86 table I, p. 80 table II) will show how futile it is to gather the requisite information directly from such tables especially when a large number of them are in view.

To overcome these difficulties it seems far better to make use of a graphic method. As will appear in the following pages, by a series of curves not only the salient features of each species are vividly brought out in contrast but far reaching results may reveal themselves when a large number of data have been thus represented. We may, for instance, hope to trace the order of variation from one species to another by a careful correlation of the curves representing homologous features of different species.

At least five out of the ten factors mentioned above can be indicated, with accuracy, on a diagram. Let the vectorial angle and number of volutions be first marked off on the abscissa, then the values of the other four factors as ordinates. Thus we obtain four different curves for each species. In order to facilitate comparison it would be best to stipulate a definite number or a symbol for each curve, and to adopt a definite scale for all species to be thus represented. As it is immaterial as to how the curves may be labeled we may, by way of a mnemonic suggestion, letter

the curve for radius vector by	r,
that for axial ratio by	a,
that for thickness of spirotheca by	l,
that for cumulative number of antetheca by	n.

Experience shows that if we take 0.1 mm. as the unit for radius vector, 0.01 mm. or 10  $\mu$  as the unit for the thickness of spirotheca and 10 as the unit for the cumulative number of antetheca, then all these curves will arrange themselves in a convenient proportion together with that for the axial ratio which may be plotted on the natural scale.

So far we have only discussed the graphic representation of *Fusulina*. It may be incidentally remarked that the application of this method can be extended to *Schwagerina* without any modification. It is only when we come to deal with the higher forms such as *Doliolina*, *Neoschwagerina*, etc. that other morphological characters must be taken into account, for these we are however at present not concerned.

(ii) *Description of the more common species of Fusulina from four localities of N. China.*

From morphological as well as structural considerations all the *Fusulinae* from N. China so far examined by the writer can be divided into three distinctly different types:—

- (a) Those with short and strongly arched test and thick spirotheca; being typically represented by

*Fusulina vulgaris* SCHELLWIEN s. str

- (b) Those with elongated or even arcuate test and relatively thin spirotheca; antetheca folded in a regular manner. This group embraces the following forms:—

*Fusulina tenuissima* SCHELLWIEN,

*Fusulina longissima* NOV. var. *arca*.

*Fusulina californica* STAFF,

*Fusulina elongata* (= *extensa*) NOV. var. *minoris*,

*Fusulina vernuili* cf. var. *sapperi* STAFF,

*Fusulina pusilla* SCHELLWIEN.

- (c) Those with their inner volutions rather inflate while the outer ones tending to elongate along the axial direction; spirotheca of medium thickness; antethecal folds rather irregular; being only represented by

*Fusulina variata* n. sp.

FAMILY *FUSULINIDAE* MÖLLER

GENUS: *FUSULINA* FISOHER

*FUSULINA FULGARIS* SCHELLWIEN

Pl. I, Figs. 1, 2.

*Fusulina vulgaris* s. str. SCHELLWIEN-DYHLENFURTH: *Palacontographica*, I VI. BAND, pp. 163-164, Taf. XIV, Fig. 1-4.



Fig. 2.

External form of *F. vulgaris* X5

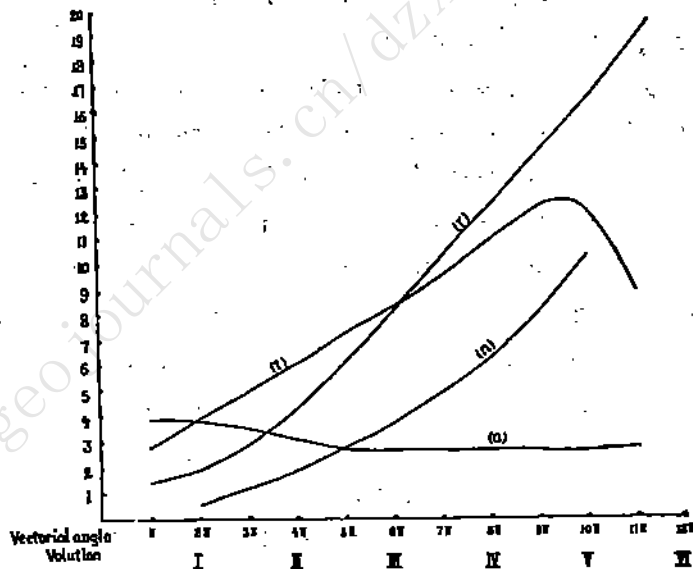

Fig. 3.—Curves showing the properties of *F. vulgaris*; for reference of *r*, *a*, *t*, *n* and scales of ordinates see p. 64.

DIAGNOSIS: Test strongly arched in the median part sloping steeply towards the poles which are often slightly extended and rounded off in the form of a papilla. Dimension of the complete test varies only slightly from individual to individual being on the average 5.4 mm. × 3.5 mm.

The half-moon shaped aperture can be seen in most of the individuals, reaching sometimes more than half the height of the chamber.

TABLE I.  
Measurements for *Fusulina vulgaris*

No. of volution.	I	II	III	IV	V	VI					
Vectorial angle.	$\pi$	$2\pi$	$3\pi$	$4\pi$	$5\pi$	$6\pi$	$7\pi$	$8\pi$	$9\pi$	$10\pi$	$11\pi$
Axial length (L). mm.	0.55	0.66	1.11	1.35	1.93	2.33	2.98	3.49	3.84	4.29	5.22
Radius vector (R). mm.	0.14	0.19	0.31	0.43	0.68	0.83	1.02	1.22	1.43	1.65	1.89
Axial ratio $\left\{ \frac{L}{R} \right\}$	3.9	3.5	3.6	3.1	2.8	2.8	2.9	2.8	2.7	2.6	2.8
Cumulative no. of antetheca.		5	12	19	29	37	50	63	82	104	
Thickness of spiro- theca	28	39	50	61	73	83	94	109	122	122	90.

Number of volutions 5 to 6.

Number of antetheca fairly large, and increases with a rapid rate towards the outer volutions.

Antetheca strongly folded in a rather irregular manner. The thick spirotheca with a coarse macula stands out in striking contrast to the thin antetheca which is barely supported by the honey-combed substance.

Each chamber is added to the preceding one in a remarkably smooth manner so that few furrows can be seen on the external side of the test.

The rapid increase of the height of the chamber as well as the thickness of the spirotheca in the first three or four volutions is highly characteristic of this species and all of its varieties—a fact clearly brought out in the diagram (Fig. 3)

Central chamber almost perfectly spherical, formed by a thin wall, and varies very little either in form or in size. The average diameter measures at 0.09 mm.

REMARKS: Little doubt can exist as to the identity of the present form with the Darwas species already cited. The same form under the name *Fusulina philipsoni* SCHELLWIEN is said to occur in Asia Minor. This however yet remains to be verified. If we only consider the form of the test, the thickness of the spirotheca and antetheca, and the form and size of the



Fig. 4

A part of a transverse section of *F. vulgaris* showing its thick and coarse spirotheca and thin antetheca; highly magnified.



central chamber, *Fusulina vulgaris* is hardly distinguishable from the globose variety of *Fusulina secalis* (= *Tricites secalicus* Girty) but the presence of a pair of somewhat divergent basal rings together with the absence of marked antethecal folds from the median region in *F. secalis* affords an unmistakable distinction between the species in question and the American species. Some of the Russian forms like *F. mölleri* and *F. krotowi* certainly show a strong affinity to the present species; the former, however, usually exhibits higher axial ratios especially in the outer whorls; and in the latter the antetheca are folded in a more regular manner, and the whorls are sometimes more numerous.

**OCCURRENCE:** *F. vulgaris* occurs in abundance in the limestones intercalated in the coal-bearing series of Sha Ho Hsien, S. Chihli.

**FUSULINA TENUISSIMA** SCHELLWIEN

Pl. II Fig. 1.

*Fusulina tenuissima* SCHELLWIEN: Palaeontographica, IIIIV Band, pp. 255-257, Taf. XIX, Figs. 7a, 7b, 8, 9.

*Fusulina cayouai* DEFRAT: Mémoires du Serv. Géol. de l'Indochine, Vol. II, Fasc. I, pp. 18-19, Pl. IV, Figs. 1-10. Ibid., Vol. III, Fasc. I, pp. 14-15, Pl. III, Figs. 1-3.



Fig. 5.—External form of *F. tenuissima*, X5.

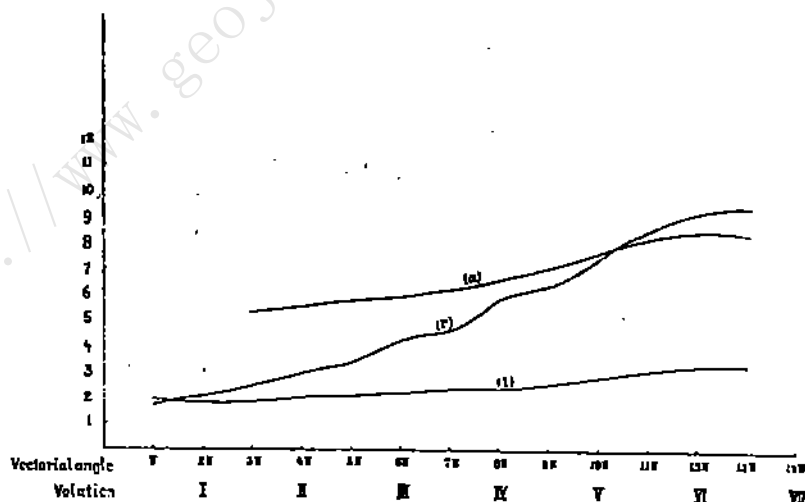

Fig. 6.—Curves showing the properties of *F. tenuissima*; for reference of a, r, t and scales of ordinates see p. 64.

DIAGNOSIS: Test cylindrical to subcylindrical, usually develops a very gentle axial curvature; poles stumpy and rounded; Dimensions 8mm x 2mm on the average.

Aperture very small; semi-circular in the inner volutions, but extends to a considerable width in the outer ones

Number of volutions usually 6, rarely 7; closely coiled.

Antethecal folding intense but regular, almost runs throughout the entire height of the antetheca which latter nearly covers the full height of the chamber. Even in the neighbourhood of the aperture the folds neither decrease in intensity nor alter appreciably their prevalent shape.

Apart from the first one or two volutions, the height of the chamber in each volution differs very little from one another.

Thickness of the antetheca is likewise uniform throughout the entire test. The tectum is inlaid by a fine macula to form the spirotheca as well as the superior part of the antetheca.

Central chamber extraordinarily large. Its form sometimes approaches an ellipsoid with its major axis more or less pointing to the poles, and sometimes quite irregular; never develops to a perfect sphere.

REMARKS: The original specimen from the Alpine Fusulina-Limestone as described and figured by Schellwien is incontestably identical with the present form. The elongated test and the regular manner of antethecal folding seem to suggest some affinity with *F. extensa* SCHELL. on the one hand, and the thin spirotheca, compressed type of coiling and unusually large central chamber indicate a still closer affinity with *F. longissima* on the other.

OCCURRENCE: *F. tenuissima* occurs in a blue and slightly bituminous limestone intercalated in the coal-bearing series of the Sha Ho coalfield. Individuals belonging to this species are not found in abundance; at least not so abundant as its associated species, *F. vulgaris* and *F. longissima* var. *arca*.

*FUSULINA LONGISSIMA* DOV. VARI. *ARCA*

Pl. II Figs. 3-6

*Fusulina longissima* MÖLLER: Mémoires de l'Académie des sciences de St-Petersbourg, VIIe sér. Tome XXV, No. 9, pp. 59-61, Tbf. I, Fig. 4, Taf. XIII, Figs. 1a, 1b, 1c.

*Fusulina longissima* SCHWAGER: Palaeontologia Indica, Series XIII, Salt-Range Fossils, pp. 988-989, Pl. CXXVI, Figs. 1a-c, and Pl. CXXVIII, Figs. 1-3.

*Fusulina longissima* MÖLL. (SCHELL-STAFF): Palaeontographica, Bd., I.V., pp. 163-165, Taf. XIII, Figs. 6 14-20



Fig. 7.  
External form of  
*F. longissima* var.  
*arca*.  $\times 5$

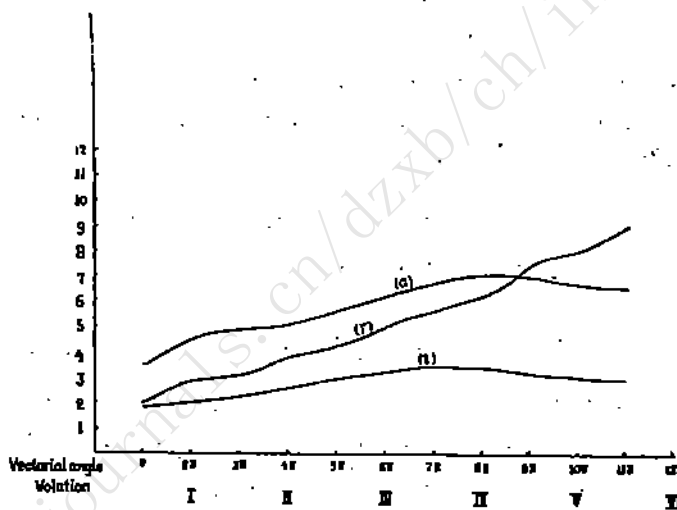

Fig. 8—Curves showing the properties of *F. longissima* var. *arca*;  
for reference of a, r, t and scales of ordinates see p. 64.

DIAGNOSIS: Test on the whole sub-cylindrical to cylindrical; occasionally with a gentle constriction in the median part, slightly expanded towards the ends for a time, but becomes pointed at the poles. The axis of the whorls is often curved at the middle so that the two arms of the test make an angle which varies from 150 to 160 degrees. Length of the test generally varies from 4.8mm to 5.5, mm, height or diameter from 1.2mm. to 1.6mm.

Aperture distinct in the inner volutions, reaching barely half the height of the chamber. If a chord be drawn in a circle at a distance of about one third of the radius from the center, then the form of the aperture would roughly agree with the smaller sector of the circle thus drawn.

Number of volutions generally 5, very rarely 6. All of them are closely coiled.

Apart from the first two volutions, antethecal folds fairly regular almost to the poles; only decrease slightly in intensity towards the median part. In the neighbourhood of the aperture about half—the lower half—of the antetheca is folded.

Antetheca and spirotheca are nearly equal in thickness, both being very thin, far thinner, for instance, than that of *F. vulgaris*.

In a transverse section the antethecas often appear in a y-shape owing to the coalescence of the lower parts of each pair of two neighbouring antethecas through folding.

Central chamber very large, generally elongated, more or less following the direction and curvature of the axis.



Fig. 9.

A part of a median section of *F. longissima* var. *arca* showing its thin spiro- and antetheca; highly magnified.

REMARKS: The characteristic features of the present variety lie in the fact that the last volution is unusually somewhat expanded near the poles of the test with the consequence that the chamber in the last volution is comparatively higher towards the poles than in median region; and that the test is bent in the middle part. The first of these features, though to some extent noticeable in *F. longissima* MÖLL. is not found in Schellwien's species, and only in rare cases it is absent from the present variety. But the second feature, namely the axial curvature, is invariably observable in all the individuals belonging to the present variety. Although arcuate forms are found in other elongated species of *Fusulina*, for instance in *F. elongata* SEUMARD, this fact needs in no way invalidate the establishment of the present variety which has quite different specific characters.

It is hardly necessary to point out the close affinity between *F. longissima* var. *arca* and *F. cylindrica* FISCHER. Schellwien actually regards one of the small arcuate varieties of "*F. cylindrica*" (see Pl. II fig. 5) as "*zu Fusulina longissima* hinneigenden Form". In the absence of a suitable nomenclature to connote its transitional character between *F.*

*cylindrica* and *F. longissima* s. str., the writer has tentatively placed it in the present variety. As a rule, *F. longissima* has a larger and less spherical central chamber, more volutions and larger dimension than *F. cylindrica*; while it has less volutions and larger axial ratios than *F. tenuissima* to which it likewise shows a strong affinity.

OCCURRENCE: *F. longissima* var. *arca* occurs in abundance in a blue limestone intercalated in the coal-bearing series of Sha Ho Hsien, S. Chihli. Here it is associated with *F. vulgaris*, *F. tenuissima* and *F. californica* to be described presently.

**FUSULINA CALIFERNICA (var. STAFF)**

Pl. II Fig. 9.

*Fusulina* aff. *tenuissima* SCHELLWIEN: Beitr. z. Pal. u. Geol. Osterr.—Ung. u. des Orients, Bd XIII, p. 101.

*Fusulina extensa* (SCHELLWIEN) var. *californica* STAFF; Palaeontographica, Bd LIX, a 183, text fig. 12. Zoologica, Heft 58, p. 80.



Fig. 10—External form of *F. californica* X5.

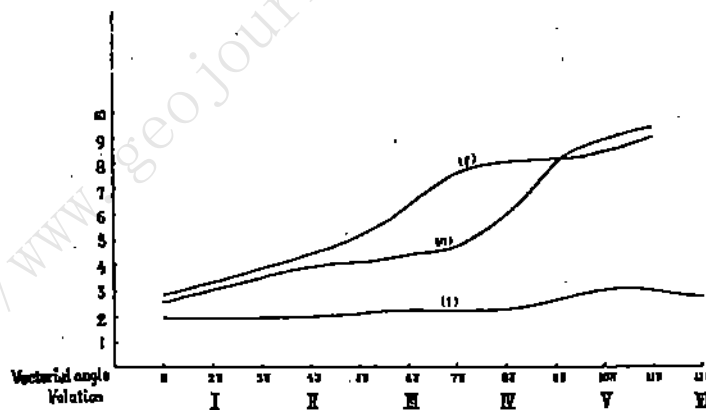

Fig. 11—Curves showing the properties of *F. californica*; for reference of *r*, *n*, *t* and scales of ordinates see p. 64.

DIAGNOSIS: The grossly elongated test is sharply vaulted on one side of the median zone with a corresponding slight depression on the opposite. From the median zone the test slopes gently and uniformly

towards the poles which are sometimes slightly extended and ended in protuberance.

Aperture indistinct. Judging from the regularity of antethecal folds in the median region, it appears that no special aperture is present as in the case of the Californian form.

Number of volutions 8 as represented by the only specimen in the writer's collection.

Antethecal fold remarkably regular, reaching a little more than half of the height of the chamber.

Spirotheca fairly thin. The thickness increases only very slightly from the inner volutions to the outer. Antetheca is likewise of insignificant thickness.

The sharp vaulting, or to be more exact the angular projection, in the median zone of the test is not only an external feature, but is exhibited to no less marked degree in most of the inner volutions, particularly in the innermost one which, when seen in the longitudinal section, assumes the form of a rhombus.

Central chamber extraordinarily large, even larger than that of *F. longissima* var. *arca*; ellipsoidal with its major axis pointing to the direction perpendicular to the axis of the test instead of parallel to it—a character which has never been observed in any other species of *Fusulina*.

REMARKS: In spite of the fact that among the material so far examined by the writer there is only a single axial section representing the present species, the peculiar vaulting in the median zone of the test, the extraordinarily large ellipsoidal central chamber with its short axis arranged in the direction of elongation of the test, the regular antethecal folding etc. make it indisputably certain that we are here dealing with a form very closely akin, if not absolutely identical to, the Californian species, *F. extensa* var. *californica* STAFF.

The thickness of spirotheca and the type of antethecal folding certainly suggest some relationship with the *tenuissima* group on the one hand, and the elongation of the test together with the type of the antethecal

folding indicates its inclination to *F. extensa*. But there are marked differences between all these species and the present one. In addition to those peculiarities as the arrangement of central chamber and the median angular vaulting that characterize *F. californica* it may be pointed out that *F. tenuissima* never attains such a length as *F. californica*; and *F. californica* in turn is in no way comparable in length with *F. elongata* (SHUMARD and GIBBY) which is said to reach 21mm or more.

The reason that Staff regards *F. californica* as figured in Zoologica Heft 58, p. 80, as a variety of *F. extensa* is probably founded on the conception that the peculiar features of the present species are rather abnormal development of individual cases than any property constant to a species. The occurrence of a form with precisely similar peculiarities in places so widely separated as California and N. China ought to prove that they well deserve to rank as specific characters. On this account it seems appropriate to separate the Californian and the present Chinese form from *F. extensa*, and regard them as an independent species.

OCURRENCE: *F. californica* is found in a blue limestone of Sha Ho Hsien, S. Chihli. It associates with *F. vulgaris*, *F. longissima*, etcas already mentioned.

*FUSULINA FLONGATA* (= *EXTENSA*) NOV. VAR. *MINORIS*.

Pl. II. Fig. 7

*Fusulina elongata* (SHUMARD) GIBBY: U.S. Geol. survey, Professional Paper, No. 58, The Guadalupian Fauna, pp. 62-65, Pl. XVII, Fig. 3, 6-8.



Fig. 12--External form of *F. elongata*  
var. *minoris*, X5.

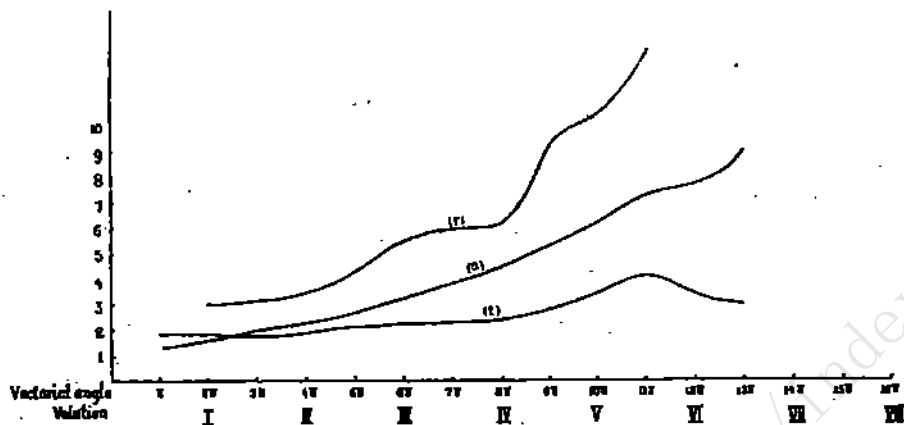

Fig. 13—Curves showing the properties of *F. elongata* var. *minoris*; for reference of *r*, *a*, *t* and scales of ordinates see p. 64.

The specific identity of this form with one of the Guadalupian species described and figured by Dr. Girty is shown by its extraordinarily slender test, thin spirotheca, rather close coiling, large central chamber and regularity of antethecal folds which as seen in the longitudinal section, appear in uniformly arranged low arcs in the inner as well as in the outer volutions. Had it not been for the smaller dimension on the part of the Chinese form, and the wide space separating the two, it would be scarcely justifiable to establish a new variety.

According to Mr. Y. T. Chao who collected and prepared the specimen, this form occurs in the lowest seam of limestone intercalated in the coal-bearing series of Chang Chu Haien, W. Shantung.

*FUSULINA VERNEULI* cf. var. *SAPPERI* STAFF.

Pl. 1, Figs. 2, 2a.

*Fusulina verneuli* (MÖLL) var. *sapperi* STAFF: Palaeontographica, Bd. LIX, pp. 181-183, Taf. XIX, XX, Fig. 13.

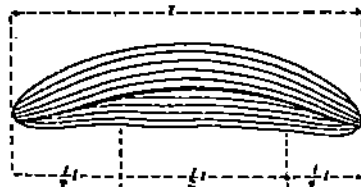

Fig. 14—External form of *F. verneuli* of var. *sapperi*; X5.



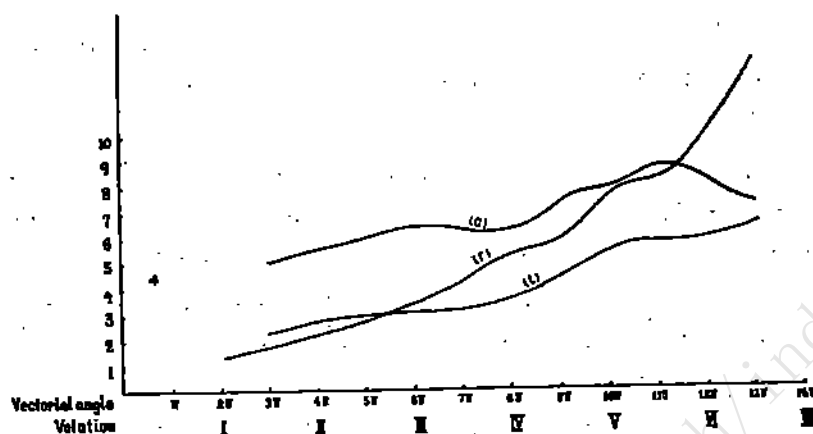

Fig. 15—Curves showing the properties of *F. verniculi* cf. var. *sappari*; for reference of a, r, t and scales of ordinates see p. 61.

**DIAGNOSIS:** Test elongated, almost cylindrical in the middle part covering about half of the entire length; the remaining one fourths bend rather abruptly towards one side of the test which is often marked in the median part, by a shallow and broad furrow running transversely to less than half the circumference. Internally only the last two volutions are involved in the bending. Average dimension 9.7mm x 2.1mm.

Aperture distinct and broad, reaching about half the height of the chamber, and forming a very flat arc.

Number of volutions 6 to 7; inner volutions rather compact, comparatively open in the outer ones.

Antethecal folds remarkably regular even in the neighbourhood of the poles; intense in the inner volutions reaching a little more than two thirds of the height of the chamber, whereas the outer ones are less intense, and are only limited to the lowest part of the antetheca. Owing to the unusual width of the aperture, there appears no folding in the median region.

The antetheca is comparatively thin; and no appreciable change in the thickness of the antetheca is observable; while the spirotheca increases its thickness from the inner to the outer volutions as does the height of the chamber.

Central chamber usually small being about 0.11 mm in diameter on the average; seldom attains the form of a perfect sphere, more often ovoid or ellipsoidal.

REMARKS: As rightly remarked by Schellwien, Staff and others, *F. verneuili* MÖLL. comprises a group of *Fusulina* which vary within a considerable range. Its most remarkable features consist in the regularity of antethecal folding, large axial ratios, uniform increase of the thickness of spirotheca and of the height of the chamber and comparatively small central chamber. Some of the forms are more inflate in the middle with volutions more numerous than usual; they then approach *F. Japonica*, others greatly elongated showing a degree of affinity to *F. extensa*. It is to the latter group of varieties that the present form is closely related.

OCCURRENCE: *Fusulina verneuili* cf. var. *sapperi* occurs in a massive blue limestone exposed at a locality 60 li to the north of Hsing An Hsien, N. Honan. Associated with it are found *F. pusilla*, *F. elongata* (SAUMARD and GIRTY) which latter, in all its external appearance resembles one of the Guadalupian forms (U. S. Geol. Survey, Prof. Paper. No. 58, Pl. XVII, Fig. 4).

*FUSULINA PUSILLA* SCHELLWIEN.

Pl. II Figs. 2 2a-b.

*Fusulina pusilla* SCHELLW. Palaeontographica, Bd. XLIV,  
pp. 254-255, Taf. XX, Figs. 8-14

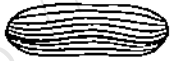

Fig. 16—External appearance of *F. pusilla*; X5.

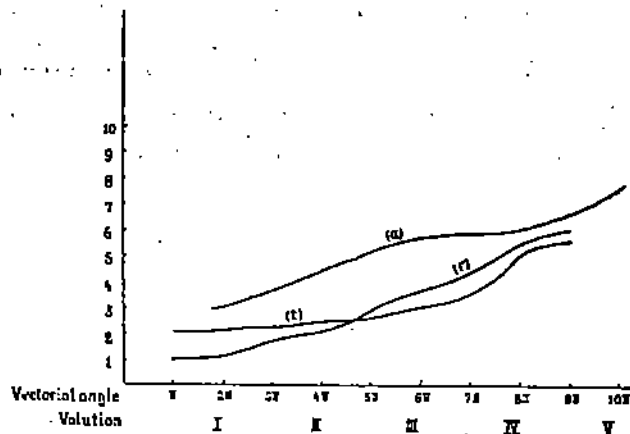

Fig. 17—Curves showing the properties of *F. pusilla*; for reference of  $n$ ,  $r$ ,  $t$  and scales of ordinates see p. 64.

DIAGNOSIS: This small *Fusulina* is characterized by its cocoon-like test when magnified, with a very gentle and broad median depression and a slight expansion at a little distance from the poles which may be somewhat pointed and inclined towards one side of the test, but more often gently rounded in the form of a highly prolate hemi-ellipsoid. In the latter case the test is almost perfectly symmetrical with respect to the axis of the whorl.

Aperture though not so broad and distinct as in Schellwien's original specimen, is nevertheless plainly discernible except in the last volution, or the last part of it. It reaches a little more than one third of the height of the chamber on the average.

Number of volutions generally 5 notwithstanding the comparatively small height of the test—a feature highly characteristic of *F. pusilla* as already remarked by Schellwien.

From a fragment of a median section it has not been impossible to count the number of antetheca for each volution, but the fact that the present species peculiarly possesses a relatively small number of antetheca in the outermost volution can be verified without doubt.

Antethecal folding regular and simple even to the ends of the test. This is seldom observed in all *Fusulina* and none in the elongated type. The folds reach more than two thirds of the height of the chamber in the inner volutions with their general arrangement not unlike those of *F. verneuili*. The intensity of the folds, however, decreases rather appreciably towards the outer volutions. In the last one or two volutions only a small fraction of the height of the antetheca is folded so that in an axial section they only present a series of extremely low arcs.

Antetheca very thin, thinner than any of the spirotheca in the test.

Whorls closely coiled; height of the chamber increases rapidly up to the third volution, but almost equal in the last two volutions.

Spirotheca fairly thin in the first three volutions; from the fourth to the fifth a rather rapid increase is observed. This increase of the thickness of the spirotheca corresponds to the increase of the height of the chamber—a fact frequently observed in other species.

Central chamber small, nearly spherical, usually 0.09 mm in diameter.

REMARKS: Among the Salt-Range species *F. kattaensis* should be the first to be cited for comparison. A degree of resemblance both in form and structure does exist between this Indian species and the present Chinese one; but the smallest individual of the former as figured by Schwager is nearly twice as long as the latter which rarely, if ever, exceeds 4.5 mm in length.

Taken as a whole, the cocoon-like shape and small dimension of the test, the low but regular antethecal folds extending even to near the poles and the compact type of coiling are the distinctive features that seem to warrant the identification of the present form with the Alpine species.

As discussed by Staff, there is a strong affinity between *F. pusilla* and some of the smaller varieties of *F. tschernyschewi* from Russia. The same author includes *F. contracta* from Drawas and *F. ellipsoidalis* from Iowa in one and the same group. This, however, seems to require a more careful consideration.

OCCURRENCE: *F. pusilla* frequently occurs in a massive blue limestone, 60 li north of Hsing An Hsien, N. Honan; always associates with *F. verneuli* cf. var. *sapperi*.

*FUSPLINA VARIATA* n. sp.

Pl. I Figs. 3, 3a-c, 4, 5.



Fig. 18—External form of *F. variata*;  $\times 5$

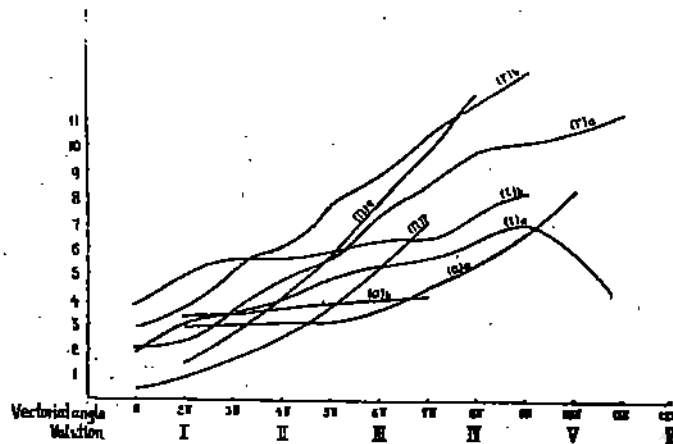

Fig. 19—Curves showing the properties of *F. variata*; for reference of the letters attached to the curves and the scales of ordinates see p. 64.

**DIAGNOSIS:** Test fusiform in the middle part and becomes abnormally elongated towards both poles through an diametrical contraction and lateral extension of the last two volutions which are as a rule sigmoidally wound. The inner volutions, however, always remain fusiform.

Aperture narrow, almost semi-circular in the first three volutions becomes very broad in the fourth and fifth with a height equals a little less than half the height of the chamber.

Number of volutions usually 5 rarely 6 in adult individuals. The first and the last volutions closely coiled, while the other volutions are relatively broad. The height of the chamber appears to vary very little in second, third and fourth volutions.

Spirotheca rather thick with a coarse macula and without any appreciable variation except for the last volution which is generally formed by a thinner spirotheca.

Antetheca is distinctly thinner than the spirotheca, especially so towards the poles; Every other antetheca is inclined forward more markedly with the result that the neighbouring ones are usually fused in the lower part, hence it appears y-shaped in the transverse section. The tectum is suddenly bent and twisted in the region where the spirotheca transforms itself into antetheca so that the latter with a layer of fairly coarse but rather

indistinct macula supporting its posterior side appears as if it were wedged into the macula of the spirotheca.

TABLE II.

Measurements of *Fusulina variata*

No. of volu- tion.	I		II		III		IV		V		VI	
Vectorial Angle.	II	2II	3II	4II	5II	6II	7II	8II	9II	10II	11II	
Radius vec- tor. mm.	a.	0.2	0.23	0.34	0.47	0.55	0.73	0.84	0.99	1.01	1.06*	1.12
	b.	0.28	0.35	0.5	0.59	0.77	0.88	1.05	1.18	1.3	—	
Axial ratio.	a.	—	2.8	2.9	2.9	3.1	3.5	4.4	5.4	6.6	8.3	
	b.	—	3.2	3.3	3.6	3.8	3.8	4				
Cumulative no. of an- tetheca.	p.	—	8	15	24	36	52	70				
	q.	—	14	25	41	56	78	98	120			
Thickness of Spiro- theca. $\mu$	a.	18	29	33	37	48	52	55	—	70	—	37
	b.	37	48	55	55	59	63	63	74	82		

Antetheca in all the whorls are, as a rule, broadly and irregularly fluted as judged from the broad and irregular dark patches that appear in the axial section. Exceptional cases are however known where a more regular type of folds can be plainly observed.

Central chamber large and perfectly spherical formed by an unusually thick wall. In one of the larger specimens the diameter of the central chamber measures at 0.33 mm, and the thickness of the wall varies from 0.028 to 0.033 mm.

REMARKS: This species is characterized by its peculiar prologation of the test, the large, thick-walled central chamber in the form of a perfect sphere, the variation in the form and size of the aperture, etc. The general feature of the inner volutions is not unlike *F. exilis* SCHWAGER. The latter however generally possesses a more fragile and somewhat smaller central chamber, and the antetheca is folded in a different type. Moreover, it never shows the tendency to develop that characteristic umbilical prolongation.

\* This value is obtained by interpolation.

Among the Russian species *F. subtilis* may be cited here for comparison. Some resemblance is shown by the photomicrographs. The fragmentary nature of Schellwien's material, the probable confusion on the part of this author of several distinct species and the discrepancy between his description and the photographs however make it extremely difficult to reach any decisive opinion as to the true relation between this Chinese form and the Russian. It may be incidentally mentioned here that the species represented by fig. 1 in Schellwien's photographs (Paleontographica, Bd. LV, Taf. XVIII) should be separated from the rest of the individuals under the specific name *F. subtilis*. It is with this particular form that our present species seems to some extent related.

**OCCURRENCE:** *F. variata* abundantly occurs in a dirty, brown, highly argillaceous limestone of Chien Tao Kou, about 15 li E.S.E. of Tai Yuan, Shansi, rarely accompanied by *F. vulgaris*.

(iii) *Some outstanding facts relating to the distribution and faunistic character of Fusulinidæ of N. China.*

Only a few Carboniferous basins in N. China, for instance, the Tien Hua and Yau Tou coalfields, N. E. Shansi,<sup>(1)</sup> and the Yang Chia Ton coalfield in the Western Hills of Peking, do we find marine limestones absent from the coal-bearing series; and only in a few of the limestones, for instance, those of the Liu Ho Kou coalfield, N. Honnan, do we find fossils belonging to the family Fusulinidæ absent. This vast and immensely rich field of fossil-Foraminifera necessitates and at the same time justifies a thorough, systematic investigation before their biological and stratigraphical significance can be fully understood. The facts indicated below, though broad and disconnected as a necessary outcome of only a preliminary survey, may however reveal points of importance for mapping out the lines of further research. The facts are.—

- (1) In N. China limestones containing Fusulinidæ are now known to occur in the following places (Fig. 20):—\*

(1) Bailey Willis and E. Blackwelder, Research in China, Vol. I, Part I pp. 149-151.  
 \* A. 新安縣. B. 興隆山, 沙河縣. C. 禮縣.  
 D. 隨城. E. 開平. F. 寧遠.  
 G. 水泉溝, 陽泉. H. 月門溝. K. 洞道溝.

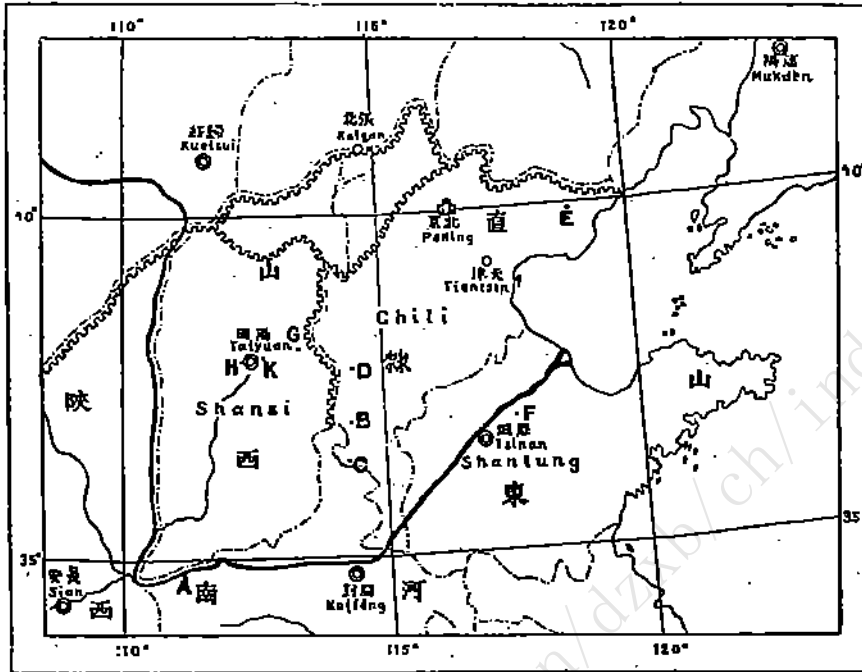

Fig. 20—A sketch map showing the distribution of *Fusulina* in N. China.

- A. 60 li N. of Hsingan-hsien.....N. Honan.  
 B. Hsin Lung Shan, about 50 li S. W. of Shaho Hsien...S. Chihli,  
 C. Tzu Chou coalfield,.....S. Chihli,  
 D. Lin Chien coalfield,.....S. W. Chihli,  
 E. Kai Ping Basin,.....N. E. Chihli,  
 F. Chang Chu coalfield,..... W. Shantung,  
 G. Shu Cihien Kou, 2.5 li W. of Yang Chien railway  
 station, Pin Ting Basin, ..... E. Shansi,  
 H. Yueh Men Kou, 30 li W. of Tai Yuan,.....Central Shansi,  
 K. Chien Tao Kou, 15 li E. S. E. of Tai Yuan,.....Central Shansi,

Apart from these localities wherefrom the writer has obtained masses of material, isolated occurrences are reported from the Po Shan coalfield, W. Shantung, the Pei Ling,<sup>(1)</sup> W. Kansu, and parts of S. Manchuria. Curiously enough, in the limestones containing a *Productus*-limestone

(1) E. Schellwien, Palaeozoische und triadische Fossilien aus Ostasien, Durch Asien, Bd III, p. 151.



fauna recently brought back by Prof. F. K. Morris from Outer Mongolia no trace of these Foraminifera has yet been found.

These Fusulinidæ-bearing limestones are almost invariably intercalated in the lower part of the Anthracolithic Formation. This would mean that they belong largely, if not entirely to the Taiyuan Series. Sometimes only a single layer of the limestone is present as in the Kai Ping basin and in the northern part of Hsing An Hsien; and attain a thickness in these cases of about 2 to 3 meters; and sometimes they occur in several seams separated by sandstones, shales and coal seams. Each seam of the limestone rarely reach 2 meters in thickness. In the Sha Ho coalfield there are, according to the local miners, no less than three layers of such limestones; some of them are extremely thin, and probably die out within a small area. In the Jen Chien basin three layers were counted by Messrs. Y. T. Chao and C.C. Tien. Five seams of these limestones were reported by these gentlemen from Chang Chu, W. Shantung. The author observed five layers in the Pin Ting basin; each of them possesses some distinct character familiar to the local miners who use them as reference strata. The lowest one which lies about 18 meters above the thick coal is known as *Yaokushi*<sup>(1)</sup> or the waist-hard-stone. Its thickness is estimated at 0.51 m. This is overlain by 0.51m. of a hard blue shale, then by a blue limestone with a thickness of 1.5m. Miners name it the *Szechehshi*,<sup>(2)</sup> or four-strata-stone on account of the fact that it is usually divided into four strata. After an interval of 6m. of well-laminated grey shale a massive, hard, blue limestone known as *Kuhshi*<sup>(3)</sup> or the hard-stone, appears in the ascending succession with a thickness of about 2.7 m. A series of shales with beds of sandstones now follow aggregating to a thickness of 21m. This is again overlain by a blue limestone, the *Chienshi*<sup>(4)</sup> or coin-stone, having a thickness of 1.2 m. The name is derived from the fact that in this limestone fragments of Crinoidal stems are often found. Still going upward for a distance of 23.3 m. of sandstones and shales the last or the highest seam of limestone comes in the sequence. This is known as *Houshi*<sup>(5)</sup> or the ape-stone, about 1.8. m. thick. Most, if not all, of these lime-stones are crowded with *Fusulina*.

(1) 腰固石 (2) 筍石 (3) 岡石 (4) 錢石 (5) 猴石

Mr. E. Norin<sup>(1)</sup> describes five seams of Anthracolithic limestones exposed in the Western Hills of Tai Yuan, and records the occurrence of *Fusulina* at two different horizons in those limestones. In a later excursion into the same district led by the writer a large quantity of *Fusulina* was found from four or five different limestones exposed at Yueh Men Kou,<sup>(2)</sup> a locality where Mr. Norin describes his classical sections. As time did not allow us to identify each of the limestones described by Mr. Norin, we are as yet not sure of the stratigraphic position of the *Fusulina*-limestones in Norin's section. But it is certain that *Fusulina* occur at more than two horizons in the hills west of Tai Yuan.

(2) The several species of *Fusulina* described here are largely cosmopolitan in character. *F. vulgaris* abound in the *Fusulina*-limestone of the Darwas district, Central Asia, forming the Lower Series of the Upper Palaeozoic formation. There, it associates, according to the list provisionally furnished by Tschernysshew, with a sparse fauna of Brachiopods and Molluscs that seem to range from the Middle Upper Carboniferous (Stage of *Spirifer supramosquensis*) to the Artinskian or Permo-Carboniferous.<sup>(3)</sup>

Although there is some question as to the exact stratigraphic position (within Upper Carboniferous) of *F. tenuissima* and *F. pusilla* in the Carnic Alpine that they belong to the Upper Carboniferous, is, as shown by Schellwien's careful correlation, a matter beyond any doubt.

*F. verneuili* cf. var. *sapperi*, *F. californica* and *F. extensa* var. *minoris* are forms that are either closely related to those found in Texas, Guatemala, New Mexico and California or actually lived in the American waters. There again the stratigraphic position of these fossils cannot be lower than Upper Carboniferous, and in some cases, as in the Capitan Formation of the Guadalupian Mountains they seem to belong to Lower Permian as shown by the *Lyttonia* fauna.

(1) E. Norin, The later Palaeozoic and Early Mesozoic Sediments of Central Shansi Bull. Geol. Survey of China, No. 4, pp. 31, 41.

(2) 月門溝.

(3) Palaeontographica, Bd. LVI, pp. 140-147.

Here then in N. China we have evidence to show the confluence of the Foraminiferal faunas that lived in the Eurasian geosyncline extending from N. China through Central Asia and probably Asia Minor reaching finally to the Alpine region on the one side; and on the other, those that flourished in the Pacific waters. The fact that these Chinese species, like the Darwas fauna, shows little relation to the Salt Range fossils is a point to be noted with interest.

If not for the apparent conflict with the evidence furnished by the Brachiopods, particularly *Spirifer bisulcatus*, the writer would not hesitate to place the Fusulina-limestone of N. China as a whole in the upper part of Upper Carboniferous.

(3) With the exception of a few places in the extreme west, for instance the Semenow Mountain, where Fütterer found *Doliolina*, by far the greatest number of species of Fusulinidæ so far found from the limestones containing these fossils belong to *Fusulina* (FISCHER), very few to *Fusulinella*, none to *Schwagerina* nor the forms higher in the biological scale. With corals they are now and then associated. When they occur together with Brachiopods, the latter are generally minute in size, sparse in distribution; in a word, they are of an impoverished type. These facts are also noted by Staff in connexion with his study of the Darwas fauna. We have therefore in N. China true Fusulina-limestone and no "Schwagerinenkalk."

(4) *Fusulinidæ* of N. China usually associate themselves freely with other Foraminifera. Among the more common genera *Textularia*, *Bygenerina*, *Endothyra*, *Saccummina*, *Hemidiscus*, *operculina* etc. frequently occur.

(5) Apart from *F. vulgaris* nearly all of the individuals belonging to different species found in the Sha Ho coalfield, and in one of the limestones of Chang Chu bear a thick calcareous deposit along the axis of the whorl, particularly in those parts where the antethecas fold themselves into an entangled complex.

A tentative deduction can be made from this curious feature. Since the calcareous deposits are found in different species it cannot be a specific character; and since such a deposit can serve the animal no imagi-

nable useful purpose, if not actually accompanied by disadvantage, it would appear that it is more likely a development resulting from unsuitable habitat than any other cause that we can postulate. This argument is to some extent favoured by the occurrence of *F. elongata (extensa)* var. *minoris* in Shantung and *F. longissima* var. *arca* in Sha Ho; for, though the former is closely related to the American and the latter to the Russian species, are distinctly smaller in size, at least smaller than those individuals which do not carry the calcareous deposit—a fact may be taken as evidence for degeneration.

Similar conclusion is reached by an argument along the same line but from a different point of view: As lime is deposited in the test the quantity of this material absorbed by the animal must considerably exceed the quantity that it can consume. And as lime is absorbed by these primitive animals, in all probability, principally, if not entirely, for the purpose of the construction of their test, so the deposition of lime simply means the incapability on the part of the animal to use the quantity of lime that it is given to absorb for the construction of a specific test. It is readily conceivable that the capacity of absorbing lime to construct a specific test must be a character innate to a particular species; while the chances of their success in accomplishing that specific purpose must be necessarily more or less governed by the external conditions under which the animal has to live. This line of argument would involve that there must have been places outside of W. Shantung and S. Chihli where the forerunners of *F. longissima* var. *arca* and *F. elongata* var. *minoris* had originated, developed, and finally migrated into N. China, and there became modified under the forces of changed environment. It is not safe to state at present where is the birth place of their ancestors. But in the absence of a nearby locality where such ancestral forms are known to occur, and in view of their close relation with the Russian and N. American fauna, one might suggest that they have migrated from these countries.

(6) The Heing An *Fusulina* fauna, in contrary to those occurring farther northeast, shows a healthy mode of development. There, the Alpine and the American types of species occur side by side.

It is therefore thought that the highways for the migration of *Fusulina* lay near the southern border of N. China.

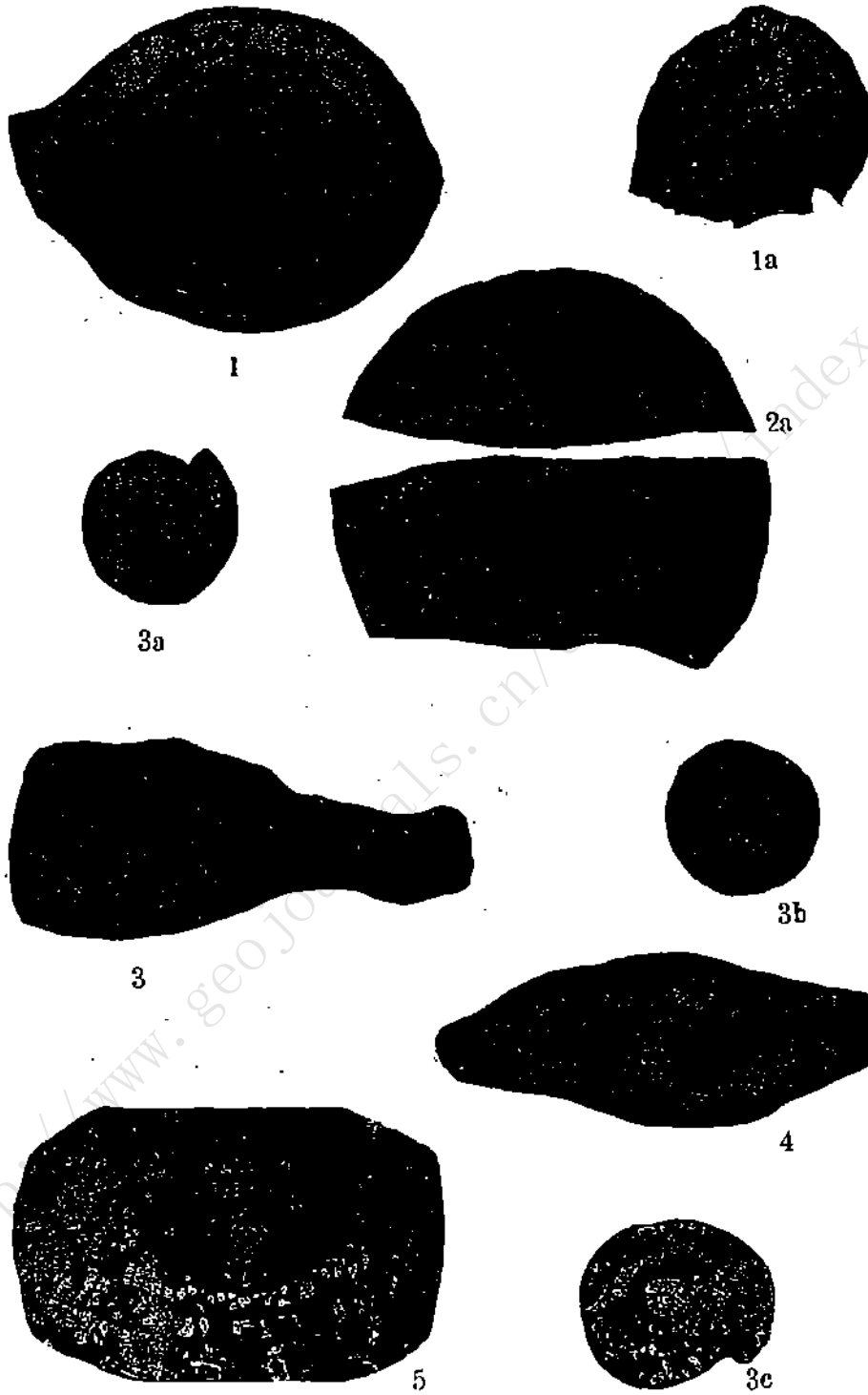

中國北部石炭紀(菱莖紀)之筴蝸 李仲揆

PLATE I

- Figs. 1,1a. *Fusulina vulgaris* SCHELLWIEN.
1. Sub-axial section showing thick spirotheca and coarse macula.
  - 1a. A transverse section with the inner volutions showing some resemblance to *Schwagerina*, but the last volution, especially the last part of it, tending to devolute in contra-distinction to *Schwagerina* which is nearly always characterized by a "senile derescence".
- Figs. 2,2a. *Fusulina verneuli* cf. var. *sapperi* STAFF.
2. A part of an axial section along the plane in which the axis of whorl is curved.
  - 2a. A longitudinal section perpendicular to the plane of axial curvature.
- Figs. 3-5. *Fusulina variata* n. sp.
3. An axial section showing extraordinary alar prolongation.
  - 3a-b. Transverse sections.
  - 3c. Median section of an individual with its central chamber somewhat deformed.
  4. Axial section of a normal individual with a perfectly spherical central chamber and incipient alar prolongation.
  5. Axial section of a well developed individual.

---

All figures are magnified to about thirteen times diameter.

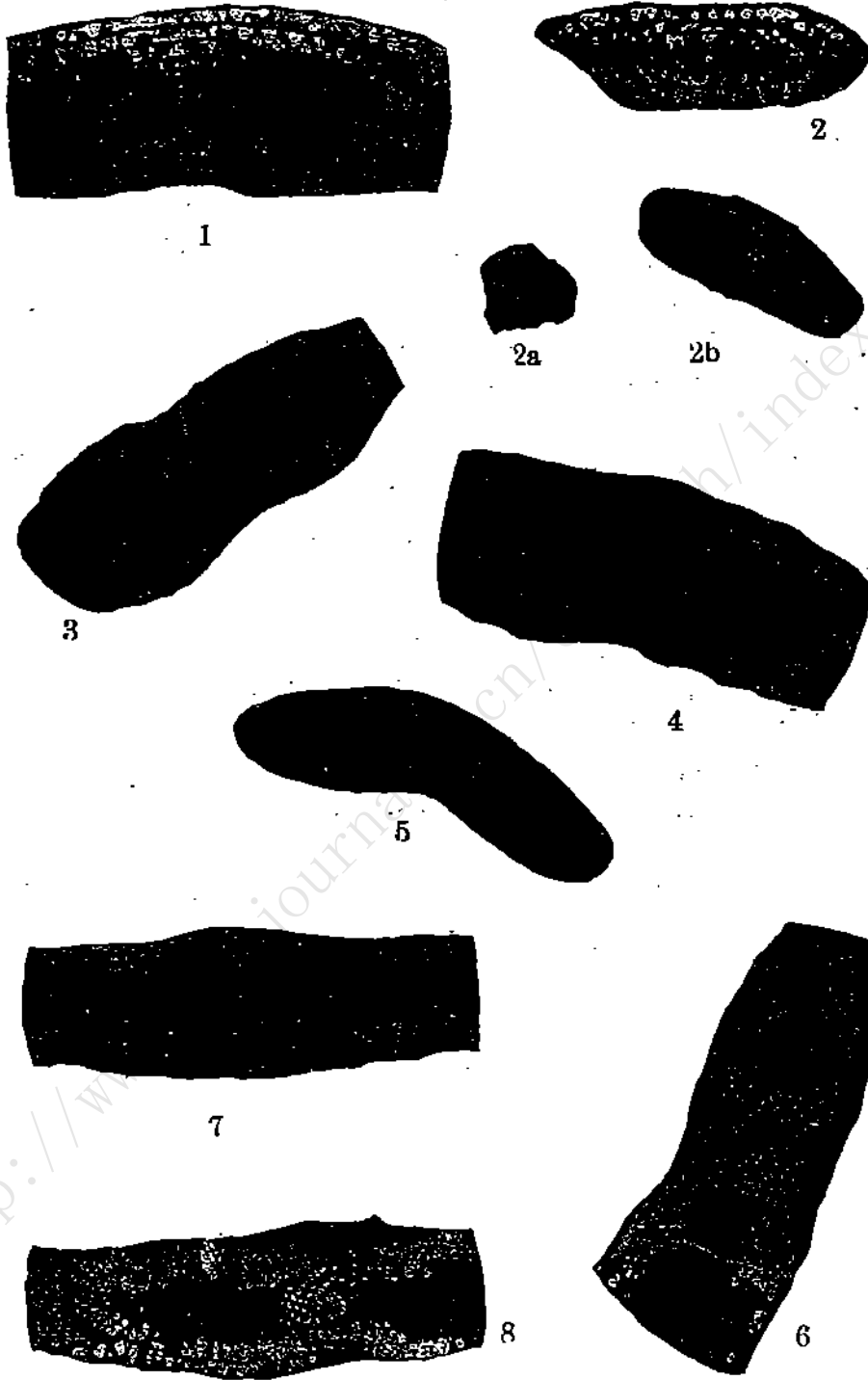

中國北部石炭紀(發達紀)之錐蝸 李仲揆

PLATE II

- Fig. 1. Axial section of *Fusulina tenuissima* SCHELLWIEN.
- Figs. 2-2b. *Fusulina pusilla* SCHELLWIEN.
2. Axial section.
- 2a. A transverse section showing the relatively small number of antetheca in the last volution.
- 2b. An oblique section.
- Figs. 3-6. *Fusulina longissima* nov. var. *arca*.
3. A longitudinal section perpendicular to the plane of axial curvature.
4. Axial section showing its thin spirotheca, elongated central chamber and regularly folded antetheca.
5. A small specimen probably representing a transitional form between *Fus. cylindrica* and *Fus. longissima*.
6. A sub-axial section of an individual with a somewhat larger test than that of the normal type as shown in fig. 4.
- Fig. 7. *Fusulini elongata (extensa)* nov. var. *minoris*.  
Axial section showing its slender form, thin spirotheca, regular and low folding of the antetheca, broad and distinct buccal aperture and numerous volutions.
- Fig. 8. *Fusulina californica* STAFF.  
Axial section showing large, ellipsoidal central chamber with its major axis perpendicular to the axis of whorl; angular vaulting in the median region (slightly shattered) and regularly folded antetheca.

---

All figures are magnified to about thirteen times diameter.



## 內 容 節 要

本篇分爲三節：第一節論研究筳蝸之方法及其各部分之名稱；並彙取古生物學家迄今研究之結果而加以批評。第二節專述中國北部已發見之筳蝸。第三節討論本篇所述各種筳蝸生存之時代及其棲息流徙之情形。

## (一)

開創古生物學之有力者法儒多比尼 (D'Orbigny) 氏當研究現在及過去海洋中纖微之生物。始立 Foraminifères 之名。漢譯爲有孔虫。謂其殼多孔也。迨後 Von Reuss, Carpenter, Parker 及 Jones 諸氏關於此類生物攷究更詳。始知多氏之所謂“有孔虫”者可分爲二屬：一屬殼多微孔名有孔屬 (Perforata)。一屬其殼無孔名無孔屬 (Imperforata)。自古生世以至今日，海洋生物羣中恒有其徒。唯其中種類繁夥。盛衰異滅，各殊其時。古生世之後期，無孔屬中之筳蝸一族最爲繁殖。遍佈於歐亞及北美各海洋中。當時中國北部海中猶多此物。至古生世之末造則無蹤類。本篇所論述者即此族也。

千八百二十九年 Fischer v. Waldheim 氏關於筳蝸之化石始有較詳之論著。列爲一類。定名 *Fusulina*。取其大多數之形狀如紡織機上之線筒然。近代日本古生物學家譯名紡織虫或紡錘虫。經諸原名，自彼國人視之，既得其音，復獲其義。可謂兩全。然稱之爲虫，則無異指鹿爲馬；呼 Dinosaur 爲龍者矣。虫之名既云於通俗之義不合，而紡錘二字，不獨不能單獨成生物之名；且就漢

• 翁文灝，駁龍解，科學，第八卷第五期，pp. 496-501

昔而論與原名絕不相符。就字義而論，在中國亦不甚普通。無已，今另立新名，姑稱爲筵<sup>5</sup>蝸。一則以符原名之義，一則以表其蝸轉之形。

Fischer 以後，研究筵蝸者時有所聞。而有重要著作者則首推麥勒 (V. v. Möller)。麥氏取材於歐俄之西北諸地，頗稱豐富。製成薄片多方攷究，乃得證實筵蝸之中爲類尚多，乃立筵蝸族 (Fusulinidae) 之名，包括筵蝸類 (*Fusulina*)，扁筵蝸類 (*Fusulinella*)，西氏蝸類 (*Schwagerina*)。自麥氏之兩次論著發表以後，筵蝸之發見漸多，論述者亦復不少，如 Schwager, Douvillé, Schellwien, 矢部, Volz, Girty 諸氏皆有所貢獻。而對於筵蝸一類薛耳賓 (Schellwien) 氏研究最詳。薛氏曾有著筵蝸族通論之偉畫，惜書未成而身已物故。狄連富 (Dyhrenfurth) 及史達夫 (Staff) 二氏繼之，乃有三次筵蝸類通論之發表。一論歐俄產，一論中亞產，一論北美產。前安南地質調查局局長戴普拉 (Deprat) 氏關於安南、雲南東部及日本之筵蝸亦曾有專著。而於筵蝸類最富之中國北部則罔有論及者，殊覺缺如。此本篇之所由作也。唯中國北部此項材料異常豐富，其生物學上及地層學上之價值，斷非短時期中所能盡行發見。本篇所論，不過崖略耳。

筵蝸之殼，大都兩端尖而中部穹起，大致與俗所謂“筵子”之形狀相類似。但其穹起之程度，不獨各種筵蝸往往不同，即同屬一種者亦時有變異。其他成長筒之狀者亦頗常見。中部收縮近兩端之處略形擴張者，間亦有之。其長尋常四五種至十一二種不等。其中部之寬十分之一種至三四種者甚爲普通。

筵蝸之內部分爲無數小房，中央之房多成球形或橢球形。

<sup>5</sup> 原始動物可否以蝸名之，尙屬疑問。茲因無相當之字，姑借用之，以待將來生物學家之修改。

甚至有方形者，名曰胎房。旋繞胎房者名旋房。旋房之壁，普通分爲兩部分，一部分爲房頂，成旋轉之勢，名旋壁，一部分爲旋壁，向中央轉折而成，垂於旋房之前面，名前壁。壁之構造多分爲兩層，內層較厚，成蜂巢狀，名殼架。外層極薄，其質亦較密，名殼表。旋壁之正切斷面，因橫斷殼架，常呈無數小孔之觀。以故古生物家前多誤以筵蝸族割歸有孔屬。今據多方攷究之結果，吾人確知此種見解之謬也。扁筵蝸類之壁純由殼表而成。葛氏蝸 (*Grabauina* n. g.) 內部之旋壁純成於殼表；外部旋壁則殼架與殼表皆具。筵蝸類之旋壁大都全由表裏二層合成，唯其前壁則具殼架者極少。

筵蝸類之前壁常有褶皺狀如波紋。隣壁之褶，凸出相聯，致每一縱房分成多數小房。自正切斷面觀之，略成斜四邊形，極爲顯然。唯西氏蝸 (*Schucagerina*) 費氏蝸 (*Verbeekina*) 桶蝸 (*Doliolino*) 新西氏蝸 (*Neoschucagerina*) 矢部蝸 (*Yabeina*) 蘇門蝸 (*Sumatrina*) 諸類之前壁，直亘於蝸殼兩端之間，不少呈褶皺之象。西氏蝸雖云偶有微褶，然較諸筵蝸類之褶皺則未可並論矣。

上述各種高級筵蝸前壁，雖無褶皺以堅其構造，而其旋房之中，則生種種形骸作同等之效用。如桶蝸旋房之底有環狀之物甚多，橫繞旋壁之外部，互相平行如桶周之鐵環然，是名底環。新西氏蝸及蘇門蝸之旋房中更有特別之構造，名曰隔壁。由殼架之一部分延長而成，與旋壁垂直，或長或短，或縱或橫不等。其長者往往與房底之底環相連接，名曰主隔壁。其不與底環相接者名副隔壁。新西氏蝸有主橫隔壁及副橫隔壁。其縱隔壁則大都爲副隔壁。唯蘇門蝸之中似有縱橫隔壁，主副皆全者。

前隔壁或主縱隔壁之下部有穴，名曰孔，爲筵蝸生時其中原質 (*Pylome*) 出入之道。孔或單或複。扁筵蝸類及筵蝸類僅

具單孔生於殼之中部。西氏蝸口孔之性質雖尚未十分證實。而從其構造上推測則應屬單孔。桶蝸新西氏蝸蘇門蝸諸類則具複孔沿前壁及主縱隔壁之下部而排列焉。

單口孔之兩旁往往有環狀之物以為屏障。其形狀一見與底環相類。而其生成之歷史則迥異。茲不詳論。暫定名曰腹帶。此筲蝸內部之構造及其各部分名稱之重要者也。

筲蝸類鑑定之法。迄今無一定之標準。學者或隨其觀察所及。擇述一二。以別種性。舉一露百。勢所必然。或記載龐雜。茫無端倪。或揭載各部分之大小以期精確。而數目浩繁。反致失其効用。

筲蝸之軀殼既甚纖細。而歷來鑑定之法又欠妥當。學者莫不懷疑。良有以也。茲據多方觀察之結果。立標準十則。學者於鑑定筲蝸之時。儘能逐條審慎。當不致發生極大之誤謬也。

(1) 旋徑對於生長期增加之率亦即旋房高度之增加率( $r$ )。

(2) 在任何生長期即旋壁上任何一點旋徑對於殼長之比  
(a).

(3) 在任何生長期旋壁之厚度( $t$ )。

(4) 在任何生長期前壁之總數( $n$ )。

(5) 旋轉之次數亦可以旋轉角表示之。

(6) 胎房之大小與其形式。

(7) 前壁褶皺之形式與其程度。

(8) 旋壁轉折為前壁之處其構造上的特色。

(9) 口孔之位置及其形狀。

(10) 全體形態上之特色。

於以上十則之中。假若以旋轉次數或旋角之值為橫距標。全時以(1)(2)(3)(4)及(6)則之一部分之值為縱距標。則每種筲蝸之重要性質。立即見諸若干曲綫。如此處理。既可免數目之煩雜。

復可避文字之紛擾且曖昧之處無由存在應用之餘殊覺於鑑定錐蝸之種類或攷其遞變之歷史不無裨益其應用之實例見本篇第二節中。

(二)

中國北部所產之錐蝸就著者曾經研究者可分為三大宗：

第一宗 殼短而中部穹起之度甚大旋壁甚厚而前壁甚薄。例如

*Fusulina Vulgaris* SCHELL.

第二宗 殼長，有時稍形彎曲旋壁頗薄前壁之褶皺極為整齊包括以下諸種：——

*Fusulina tenuissima* SCHELL.

*Fusulina longissima* var. *arca* n. var.\*

*Fusulina californica* (var. STAFF)

*Fusulina elongata (extensa)* SCHELL. s. str.

*Fusulina elongata (extensa)* var. *minoris* n. var.

*Fusulina verneuili* cf. var. *Sapperi* STAFF.

*Fusulina pusilla* SCHELL.

第三宗 內部諸旋穹起之度甚大外部數旋則向兩端延長旋壁不甚厚前壁之褶皺不甚有規則為其代表者有

*Fusulina variata* n. sp.

(三)

此次研究之結果較為重要者可分為數項擇錄如次：——

(1)錐蝸類最大多數產於大煤紀 (Anthracolithic) 之石灰岩中間亦有擁雜於灰質甚重之頁岩中者此項錐蝸石灰

\* 暫定之名稱

岩在中國北部分佈甚廣.已經證實者有以下諸地點:

地名		層數
直隸	唐山	一層
	臨城	一層
	磁縣	?
	沙河	三層?
山西	調道溝 (太原東南十五里)	一層
	月門溝 (太原西三十里)	三層?
	陽泉	四層
	保德	一層?
山東	章邱	二層?
河南	新安 (距城北六十里)	一層
	甘肅	北嶺

(2) 中國北部所產筵蝸族之化石,除甘肅西北外,屬於筵蝸類者十居八九.扁筵蝸類次之.葛氏蝸 (*Grabauina*) 及秀氏蝸 (*Schubertella*) 又次之.西氏蝸及其他高級之筵蝸則皆絕迹.

(2) 與筵蝸類為羣之生物大都皆係 Foraminifères 之屬.如 *Endothyra*, *Textularia*, *Bigenarina*, *Succammia* 等類.偶有珊瑚,海百合腕足及三葉之類全見於一處.但產筵蝸之石灰岩中,此類此生物為數甚少.且甚發育多不完全.

(4) 前述之 *Fusulina vulgaris* 一種,與產於中亞之帕米爾高原附近之 Darwas 地方者完全相同.應屬於石炭紀(段蓬

紀)之後期.在中國北部屢見於直隸沙河煤田之石灰岩中間亦產生於山西太原東南之澗道石灰岩中.唯產於此處者與 *Fusulina krotovi* 酷似.因未經詳細鑑定,未便斷言.其為 *F. vulgaris* 之屬,則無疑義也.*F. krotovi* 在俄國為石炭紀(後蓮紀)最後期之化石.

*Fusulina tenuissima* 產於直隸沙河.與阿耳魄士東部所產者完全相同.此種亦屬於後蓮紀(上部石炭紀).

*Fusulina longissima* var. *arca* 產於沙河陽泉.與 Möller 及 Schellwien 二氏所述之 *F. longissima* 雖不無稍相出入之處.而其胎房之大.旋壁之薄.前壁褶皺之形式與程度.已足證明中國北部產與俄國產相關之密切.且其中有體小而彎曲之品.在俄國薛氏劃歸 *F. cylindrica* 今則納諸 *F. longissima* var. *arca* 之中.其為同種.似無可疑.果爾.則其屬於後蓮紀也明矣.

*Fusulina pusilla* 產於河南新安與阿耳魄士東部所產者相同.亦當屬於後蓮紀.

*F. elongata* (*extensa*) 產於河南新安.其長有近二十種者.其體彎曲.就外觀而論.與美國南部所產者無差異可辨.唯其內部之結構是否相同.尚未證實.故未列入前表之中.又據 H. H. Hayden 之報告.波斯之 Bamian 地方亦產此種.其與美國及中國北部之產究竟是否完全一致.雖屬疑問.而彼此相關之密切則不待論矣.

其他若 *F. californica*, *F. verneuli* cf. var. *sapperi*, *F. elongata* (*extensa*) var. *minoris* 或與北美後蓮紀所產者酷似.或完全一致.在中國或見於沙河.或產於山東章邱.其所屬之時代當與美國產無大差異.

前表之中,唯 *F. variata* 一種為中國北部之新種,其在地層中垂直分佈之範圍未能率爾斷定,然觀其發育完全,且與 *F. vulgaris* 相雜處等事實,則其中至少有一部分與後者同時,換言之即至少後葭蓬紀時亦產此物。

總觀全局,中國北部之筳螞石灰岩似多屬於上部石炭紀(後葭蓬紀 Uralian),而據葛利普教授鑑定腕足類及珊瑚類之結果,則謂太原段岩層應屬於下部石炭紀(前葭蓬紀 Dinantian)之後期,豈筳螞石灰岩之分配不限於太原段歟,抑尚有層位較低者而猶未曾發見耶,事實不詳,未可概論。

- (5) 河南新安之石灰岩中所產之筳螞,半屬歐式,半屬美式,其發育亦皆健全,由此以推,當後葭蓬紀之時,中國北部南部似為歐美海洋微生物流徙之坦途,此種現象之意義頗耐思索,因涉及理論,茲略之。
- (6) 中國北部所產之筳螞,與中國西南部及安南印度北境所產者關係極少,而與中亞,東南歐,歐俄及 Sritzbergen 一帶所產者關係反較為密切,由此觀之,顯然中國中部,當時不便於此類生物之流徙也。